



YARD FORCE®

OUTDOOR POWER EQUIPMENT

Model NX100i

ROBOTIC MOWER OPERATOR'S MANUAL

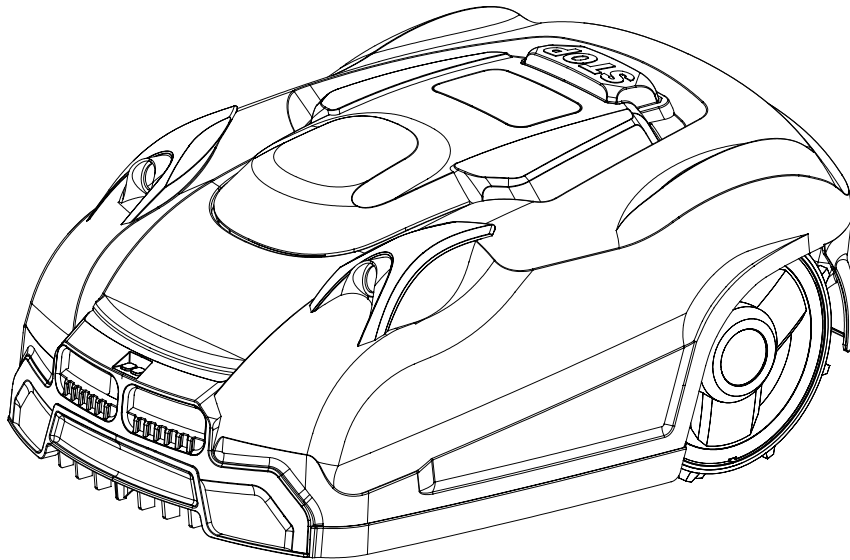

Our Customer Service staff is ready to provide assistance.

In the case of a damaged or missing part, most replacement parts ship from our facility.

For immediate help with assembly, or for additional product information, visit www.YardForceUSA.com or email support@MerotecUSA.com



SAVE THIS MANUAL FOR REFERENCE

You will need this manual for safety instructions, operating procedures, and Warranty.

The original sales receipt is required for warranty service.

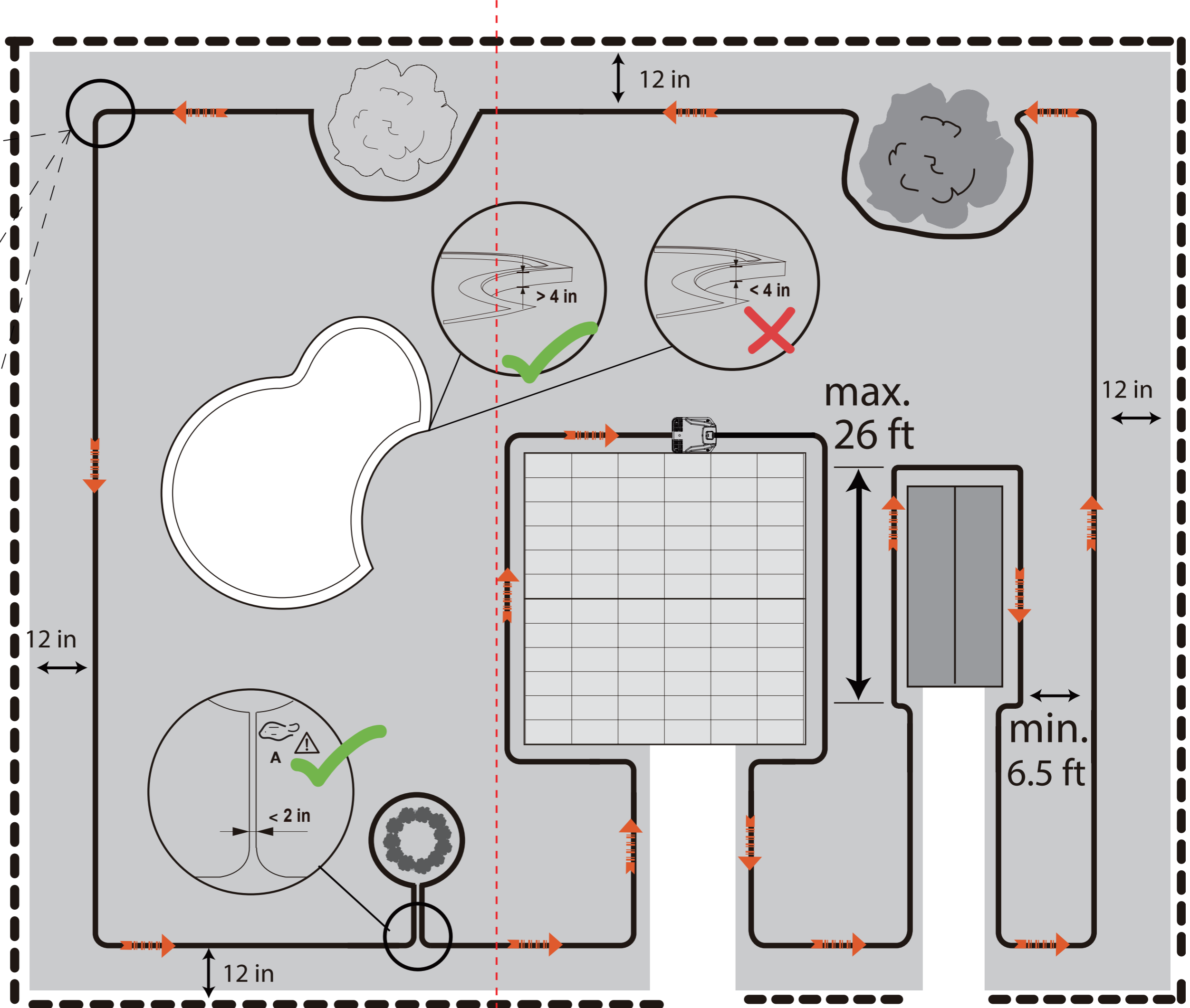
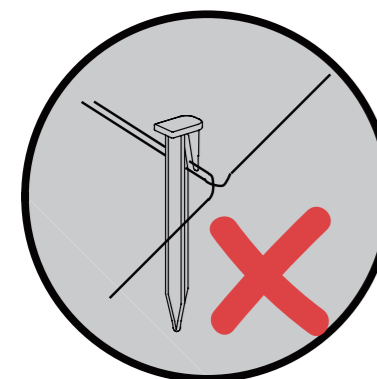
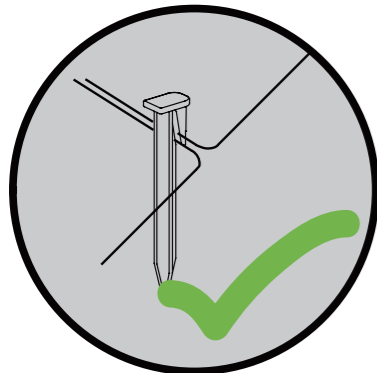
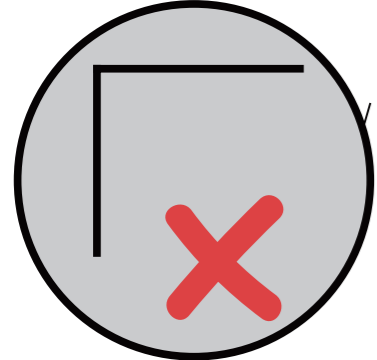

TABLE OF CONTENTS

Safety Instructions.....	5
Parts List.....	10
Intended use.....	11
Technical Specifications	11
Assembly.....	12
Operation	20
Maintenance and Storage	25
Trouble shooting	28
Warranty	30

SAFETY INSTRUCTIONS

SAFETY SYMBOLS

The purpose of safety symbols is to attract your attention to any possible dangers. The safety symbols and their explanations deserve your careful attention and full understanding. The symbol warnings do not, by themselves, eliminate any danger. The instructions and warnings they give are no substitute for proper accident prevention measures.

⚠ WARNING !

Be sure to read and understand all safety instructions within this operator's manual, including all safety alert symbols such as "DANGER," "WARNING," and "CAUTION" before using this tool. Failure to follow all instructions listed below may result in electric shock, fire and/or serious personal injury.

SAFETY ALERT SYMBOLS: Indicate DANGER, WARNING, or CAUTION. May be used in conjunction with other symbols or pictographs.

SYMBOL MEANINGS

This page depicts and describes safety symbols that may appear on this product. Read, fully understand and follow all instructions on the machine before attempting to assemble and operate.



Caution!
These instructions must be read.



Danger of injury due to flung-out material! Keep bystanders well away from the machine.



WARNING - Do not ride on the machine.
CAUTION - Do not touch rotating blade.



WARNING – Keep your hands and feet away from the rotating blades. Never place your hands or feet close to or under the body when Robotic Mower is in operation.



Return any discarded batteries to your local dealer, collector or recycle point. It is not permitted to dispose of this product as normal household waste. Please recycle where facilities exist. Check with your local authority or retailer for recycling advice.



Class III equipment

SAFETY INSTRUCTIONS

Warning Symbols on the switching power supply



Before use, refer to the corresponding paragraph in the manual.



Double insulation.



Waste electrical products should not be disposed of with household waste. Recycle where facilities exist. Check your local authority or retailer for recycling advice.



SMPS (Switch mode power supply unit) incorporating a short-circuit-proof safety isolating switching power supply.



SMPS(Switch mode power supply unit)

Ta: 113°F Rated maximum ambient temperature 113°F



Transfrom is for indoor use only.

Warning Symbols on battery pack



Batteries contain Li-Ion and should not be disposed with general household waste. Contact your local authority for disposal advice.

Li-Ion



Do not throw into water.



Do not throw on to fire.



Do not subject the battery to strong sunlight over long periods and do not leave it in high temperatures.(max. 113°F).



Waste electrical products should not be disposed of with household waste. Recycle where facilities exist. Check your local authority or retailer for recycling advice.

WARNING: Cancer and Reproductive Harm-www.P65Warnings.ca.gov

FEDERAL COMMUNICATIONS COMMISSION INTERFERENCE STATEMENT

This equipment has been tested and found to comply with the limits for a Class B digital device, pursuant to Part 15 of the FCC Rules. These limits are designed to provide reasonable protection against harmful interference in a residential installation. This equipment generates, uses and can radiate radio frequency energy and, if not installed and used in accordance with the instructions, may cause harmful interference to radio communications. However, there is no guarantee that interference will not occur in a particular installation. If this equipment does cause harmful interference to radio or television reception, which can be determined by turning the equipment off and on, the user is encouraged to try to correct the interference by one or more of the following measures:

--Reorient or relocate the receiving antenna.

SAFETY INSTRUCTIONS

- Increase the separation between the equipment and receiver.
- Connect the equipment into an outlet on a circuit different from that to which the receiver is connected.
- Consult the dealer or an experienced radio/TV technician for help.

GENERAL SAFETY WARNINGS

! WARNING !

This machine can cause serious injuries. Follow instructions below to reduce risk of accident and injury.

IMPORTANT

**READ CAREFULLY BEFORE USE
KEEP FOR FUTURE REFERENCE**

PREPARATION

- Read the instructions carefully and make sure you understand them fully. Be familiar with the controls and the proper use of the machine.
- Never allow children, persons with reduced physical, sensory or mental capabilities or lack of experience and knowledge or people unfamiliar with these instructions use the machine.
- Local regulations may restrict the age of the operator. Children should be supervised to ensure that they do not play with the appliance.
- The operator or user is responsible for accidents or hazards occurring to other people or their property.
- Ensure the correct installation of the perimeter boundary system as instructed.
- Periodically inspect the area where the machine is to be used and remove all stones, sticks, wires, and other debris which could cause damage to the machine or be unsafe.
- Periodically visually inspect to see that the blades, blade bolts and cutter assembly are not worn or damaged. Replace worn or damaged blades and bolts in sets to preserve balance.
- On multi-spindle machines, take care as rotating one blade can cause other blades to rotate.
- Never leave the machine to operate unattended, especially while other people such as children and pets are in the area.
- Never use the machine to level out uneven patches.
- If the blades no longer cut correctly or if the motor is overloaded, check all the parts of your equipment and replace the worn parts. If a more extensive repair is required, contact the customer service centre.

USE

- Do not put hands or feet near or under rotating parts.
- Never pick up or carry the machine while the motor is running.
- Remove the plug from the mains or remove the disabling device:
 - before clearing any blockages.
 - before checking, cleaning or maintaining the machine.
 - after striking a foreign object to inspect the machine for damage.
 - if the machine starts to vibrate abnormally, and to check for damage before restarting.
- Start Robotic Mower according to the instructions. When the main power switch is in the ON position, make sure you keep your hands and feet away from the rotating blades.
- Never lift the Robotic Mower or carry it around with the mains switch is in the ON position.
- Do not let persons use the mower who do not know how it works or behaves.
- Do not put anything on top of the Robotic Mower or its docking station.
- Do not use the Robotic Mower with defective blade discs, body, defective blades, screws, nuts etc.
- Avoid operating the machine in wet grass. Doing so can cause additional wear and tear, and will increase the amount of cleaning required.

SAFETY INSTRUCTIONS

WORK INTERRUPTIONS

- After the machine has been turned off, the cutting cylinder will continue to rotate for a few seconds. Keep hands and feet well away.
- Switch off the device. Only remove blockages when the machine is standing completely still.
- Switch off the power when the machine is transported, lifted or tilted.
- Never leave the machine unattended. Children should be supervised to ensure that they do not play with the appliance.

⚠ CAUTION

The following below outlines measures to avoid damage and harm to both the Robotic Mower and people using it.

TAKING CARE OF YOUR MACHINE

- Switch off the power when the machine is to be carried across uneven surfaces, for example steps.
- Inspect the machine before each use. Never operate the machine if safety devices (e.g. impact protector, parts of the cutting facility or bolts) are missing, worn out or damaged. Check the power cable for damage. To avoid imbalance, all tools and bolts must be changed as complete sets.
- Only use spare parts and accessories that have been supplied or recommended by the manufacturer. The use of alien parts results in the immediate loss of all guarantee claims.
- Ensure that all nuts, bolts and screws are firmly tightened and that the machine is in a safe working condition.
- Never try to repair the machine yourself, unless you have been trained accordingly. All work that has not been listed in these instructions must only be carried out by authorised servicing agencies.
- Treat the machine with the greatest care. Always keep the tool clean. Follow the maintenance instructions.
- Never overload the machine. Always work within the specified capacity range. Do not use low-power machines for heavy-duty work. Do not operate the machine for purposes for which it is not intended.

ELECTRICAL SAFETY

⚠ CAUTION

The following states how to avoid accidents and injuries due to electric shock:

- Before each use, carry out a visual inspection of the power and length and type of extension cords to be used (not lighter than required by Clause 25.7) for any signs of damage or ageing. Damaged mains power cables increase the risk of electric shock.
- Connect the machine to a power socket with a residualcurrent circuit breaker that has a rated current of no more than 30 mA.
- Always keep the extension cable well away from the cutting tools. Should the power cable become damaged during work, instantly disconnect the power cable from the mains. **DO NOT TOUCH THE POWER CABLE BEFORE IT HAS BEEN DISCONNECTED FROM THE MAINS!** Risk of electric shock.
- The supply cord cannot be replaced. If the cord is damaged the appliance should be scrapped.
- Keep extension cable away from blades and other moving parts. They may damage the cable and result in contact with live parts.
- Check that the mains voltage is the same as indicated on the rating plate.

MAINTENANCE AND STORAGE

- Keep all nuts, bolts and screws tight to be sure the machine is in a safe working condition.
- Replace worn or damaged parts for safety.
- Ensure that only the recommended replacement cutting blades are fitted.

SAFETY INSTRUCTIONS

- Ensure that batteries are charged using the charger supplied or recommended by the manufacturer. Incorrect use may result in electric shock, overheating or leakage of corrosive liquid from the battery.
- Servicing of the machine should be carried out according to manufacturer's instructions.
- In the event of leakage of electrolyte, flush with water neutralising agent, seek medical help if it comes into contact with the eyes.
- Store the appliance with battery pack fully charged at room temperature (around 68°F).
- Every deep discharge cycle decreases the capacity of battery pack. To prolong battery life, it is recommended to charge the battery every 6 months over extended periods of time without use.

TRANSPORT

The original packaging should be used when transporting the Robotic Mower over long distances.

To safely move from or within the working areas:

- Press the STOP button to stop the mower.
- Move the main switch button to the OFF position if you intended to carry the mower.
- Carry the Robotic Mower using the handle below at the rear. Carry the mower with the blade disc away from the body.

PRODUCT SAFETY WARNINGS

Not to touch moving hazardous parts before these have come to a complete stop.

Do not store anything heavy on the top of the Robotic Mower or docking station both during storage or when in use.

Never use the device if the main power switch is damaged or does not work properly. Never modify the main power switch. Set the main power switch to OFF for storage or when the device is not in use. Use the original packaging when transporting the Robotic Mower, especially for long distances.

If you need to carry the Robotic Mower from or within the working area, first press the STOP button to stop the device.

Secondly, ensure that the main power switch is switched OFF before you lift up your Robotic Mower.

Thirdly, carry the Robotic Mower by the carrying handle at the rear under the mower, keeping the blade disc away from your body as shown.

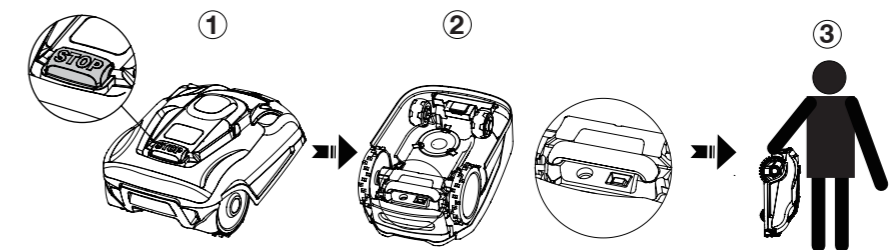

LIGHTNING PROTECTION

In order to prevent lightning damage to the machine, do not place the docking station under tall trees.

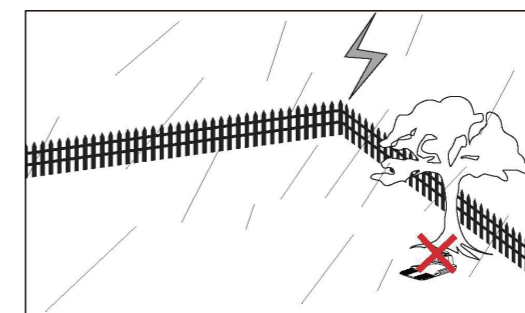

PARTS LIST

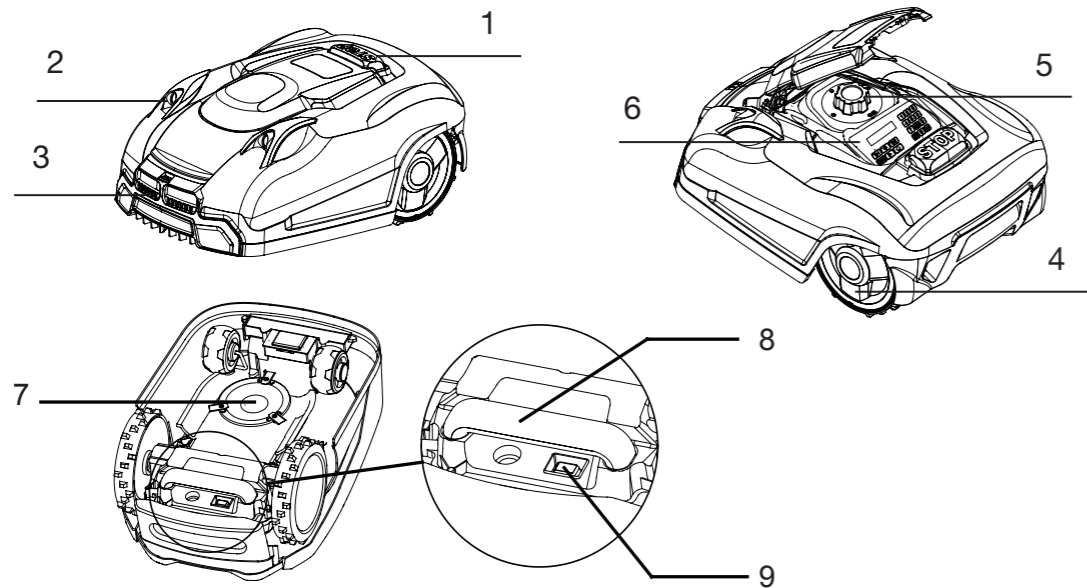

1. STOP button
2. Ultrasonic sensor
3. Charging inlet
4. Rear wheel
5. Height adjustment dial
6. Control panel
7. Blade plate
8. Carry handle
9. Power switch button

SCOPE OF DELIVERY

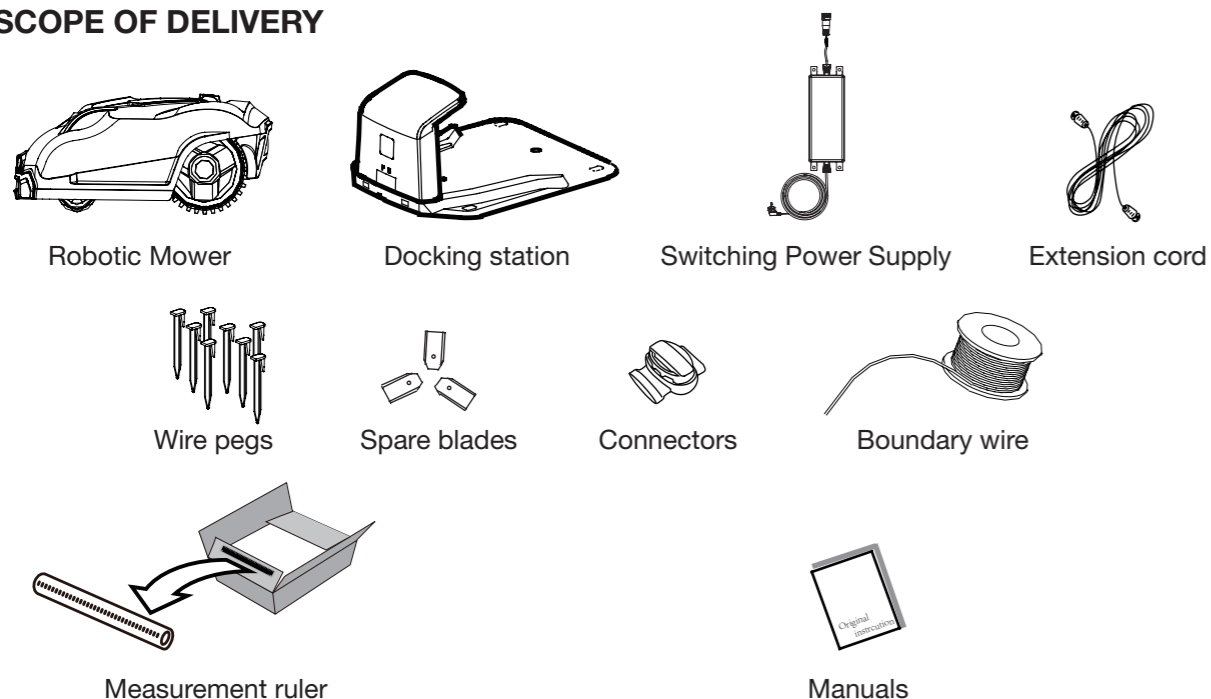

INTENDED USE

The Robotic Mower is exclusively designed for mowing lawns. It is only intended for private use and is not suitable for commercial use.

Any other use that is not specifically approved in these instructions can result in damage to the Robotic Mower and could be a serious danger to the user.

This appliance **MUST NOT** be used by children and persons with reduced physical, sensory or mental capabilities or lack of experience and knowledge, unless they have been given supervision or instruction concerning use of the appliance by a person responsible for their safety.

Children should be supervised to ensure that they do not play with the appliance.

The owner or operator is responsible for accidents or harm to others people and their property.

The manufacturer cannot be held liable for damage caused by other incorrect operation of the Robotic Mower or if it is not used in line with its intended purpose.

TECHNICAL SPECIFICATIONS

TECHNICAL SPECIFICATIONS

Model	NX 100i
Max cutting area	1/3 Acre
Battery pack	28 V/ 2850 mAh
Switch power supply	Input: 100-120 VAC, 50/60 Hz, 56 W Output: 32V $\overline{\text{---}}$, 1.5 A
Power supply model*	FY3201500S3
Mowing time on one charge	80 min
Rated voltage	28 V
Rated power	50 W
No load speed	3500 min ⁻¹
Cutting width	7 in
Cutting height	1-1/3" - 3"
Charging time	90 min
Blade model	846210
Weight	18.7 lb
Frequency Band	0-148.5 kHz
Magnetic Field Strength	70 dB μ A/m
Wifi Frequency Band	2400~2483.5MHz
Wifi Magnetic Field strength	20dBm
Max sound pressure level	L _{DA} =53 dB, K=3 dB
Max sound power level	L _{WA} =64 dB, K=3 dB
Degree of protection:	
Robotic Mower	IP24
Switching power supply	IP67, Plug IP44
Spare parts	
Spare Blades	9 Pcs
Boundary pegs	220 Pcs
Boundary wire	720'
Connectors	6 Pcs

* WARNING: For the purposes of recharging the battery, only use the detachable supply unit provided with this appliance.

ASSEMBLY

Installation Guide

This chapter explains how to install the Robotic Mower. Please read this completely before you start the installation.

Introduction

We recommend creating a drawing of your lawn, including all obstacles and how these should be protected. This makes it easier to find a good position for the docking station and how to correctly place the boundary wire around your garden perimeter protecting bushes, flower beds etc. You will also need some tools, like a hammer and wire cutters, pliers or scissors.

Pre Cut your lawn

Your lawn needs to be prepared correctly, prior to installing the robot lawnmower. Pre cut your lawn to a height of 2.5 in.

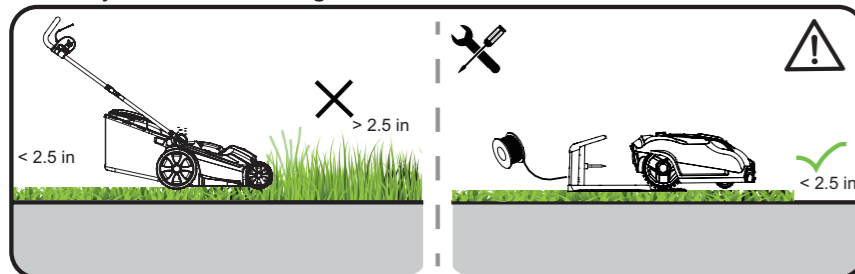

Cutting limitations

The Robotic Mower is equipped with collision sensors. These detect all rigid and solid obstacles that are higher than 4 in, such as walls, fences and garden furniture.

When the sensors report an obstacle, the Robotic Mower stops, backs up and then mows in a different direction. As a long-term solution, it is recommended to lay the boundary wire accordingly using the ruler to protect obstacles and the device. Lay the boundary wire so that the Robotic Mower is not more than 65 ft away from the boundary wire at any point in the mowing area.

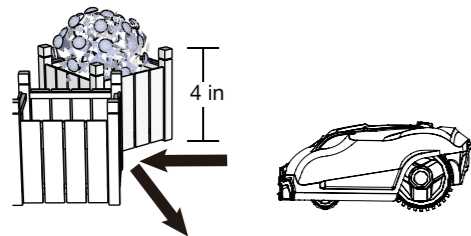

Trees

The Robotic Mower treats trees as common obstacles, but if the roots of the tree are exposed and lower than 4 in, this area should be excluded using boundary wire in order to protect the tree root, cutting blades or rear wheels from damage.

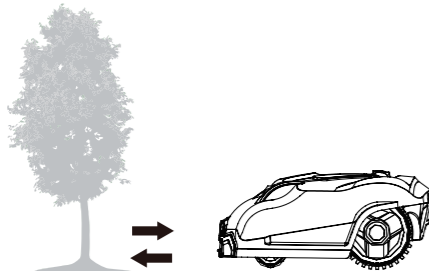

ASSEMBLY

Stones

We recommend clearing the lawn of small (less than 4 in high) rocks and stones and any stones with a round or sloped edge. The Robotic Mower might try and climb such rocks instead of recognising them as a barrier. The Robotic Mower getting stuck on such a stone requires user intervention to restart mowing. Contact with stones can result in damage to the blades.

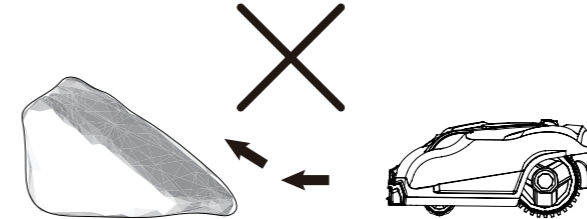

Slopes

The Robotic Mower can navigate slopes up to a maximum of 40% incline or decline.

The boundary wire should never be perpendicular to an incline of more than 10%. Also, leave strip of at least 6.5 ft between a slope of 10% or steeper and the boundary wire. Otherwise, the higher speed going down the slope may cause the Robotic Mower to go over the boundary wire, especially on wet and slippery ground.

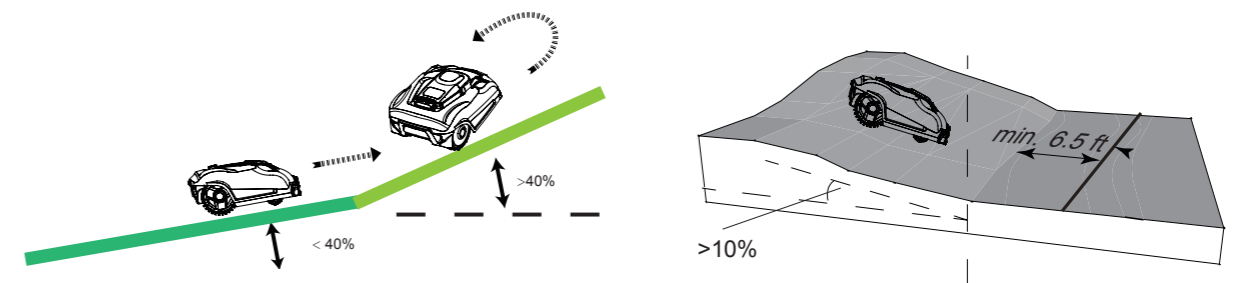

Paths, Driveways and Roads

If an elevated driveway crosses your lawn, better keep it outside the boundary wire. Please allow a safety distance of 12 in between driveway and boundary wire.



ASSEMBLY

If the driveway and lawn are at the same level, feel free to use the boundary wire to create a corridor. This allows your Robotic Mower to cross the driveway and reach the opposite lawn.

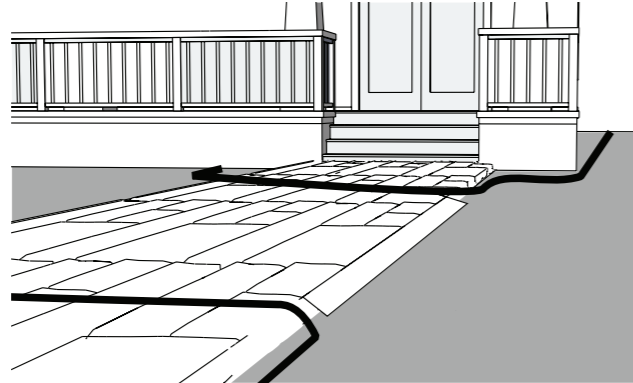

Uneven lawn surfaces

Uneven lawn areas may cause the blades to touch the ground. We recommend leveling the lawn before using your Robotic Mower or excluding uneven areas with the boundary wire.

Placing the docking station

Locate the best position for your docking station. Be aware that it needs a permanent connection to the mains, so take into account the location of the nearest power outlet.

To ensure the Robotic Mower can return to the docking station smoothly, leave 5 ft of straight wire to the front of the docking station and 12 in to the side facing the cutting area. Use a shaded location for the docking station, as a lower temperature while charging is beneficial to the battery.

Important: Place the docking station on an even, flat surface away from ponds, pools or stairs.

We recommend suitable protection from the elements, for example a robot port or garage.

Do not place the docking station too close to a slope, such as at the top of a hill or the bottom of a furrow. Avoid left and right inclination in excess of 5 degrees.

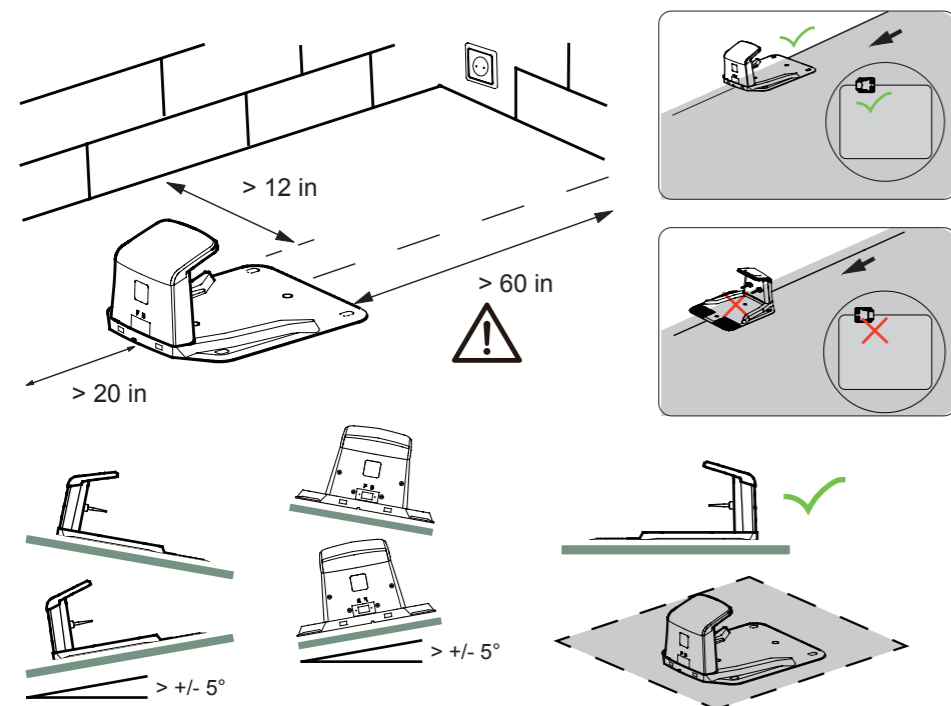

ASSEMBLY

If your lawn has a soft or uneven surface, we recommend fortifying the area around the docking station with a grass protection mesh. Otherwise, the repeated stress of the rear wheels can damage the turf. Once the position of the docking station is confirmed and mains electrical connection is laid out, please do not connect to main power yet. Finish all boundary layout work before connecting the docking station to the power supply.

Pegging your boundary wire

We strongly recommend mowing the lawn to 2.5 in or less before laying out the boundary wire. Burying the boundary wire is entirely optional. Still, the closer to the ground you lay out the boundary wire, the lower the chance of tripping over it or damaging it when mowing the lawn.

Use the included ruler to ensure the required 12 in distance between wire and obstacles.

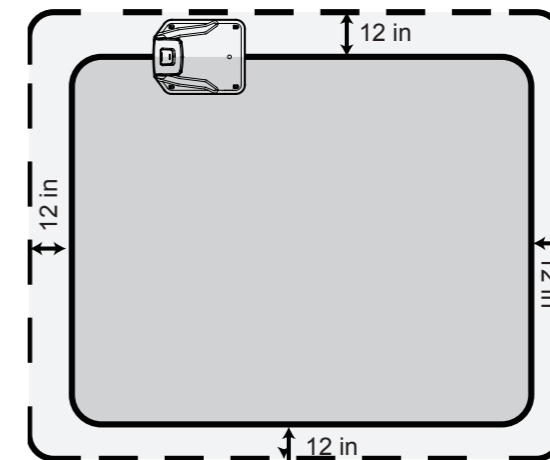

The recommended distance between two pegs is about 30 in in straight lines, and less in tight curves. Note that the pegs' hook and wire slit always faces the outside of the boundary. Within a short time the cable will be covered with grass. Since the voltage is only 32 V, there is no risk of electric shock. Make sure that the hook of the peg and the opening for the cable always face the demarcated.

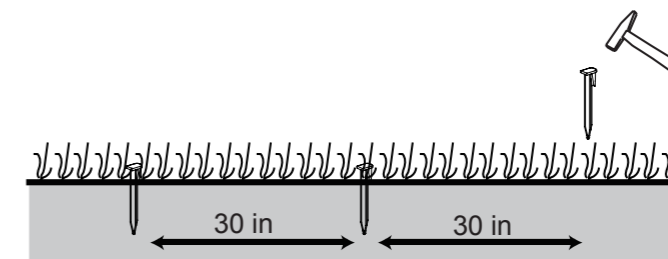

When first planting the pegs, do not drive them fully into the ground. Use a light hammer to drive them in a little bit. Also locate the fixing pegs and lay each one on the lawn at approximately the correct distance from lawn edges (12 in) and obstacles.

ASSEMBLY

Flowerbeds

Use the boundary wire to exclude any flowerbeds from the cutting area. There are two options for the two lengths of boundary wire running between the flowerbed and the outer boundary:

1) Keep the distance between the parallel wires above 2 in. This way, the Robotic Mower will recognise the boundary wire as an ordinary obstacle. When cutting, it will "bounce" off it as usual. When following the boundary wire back to the docking station, it will take the detour around the flower bed.

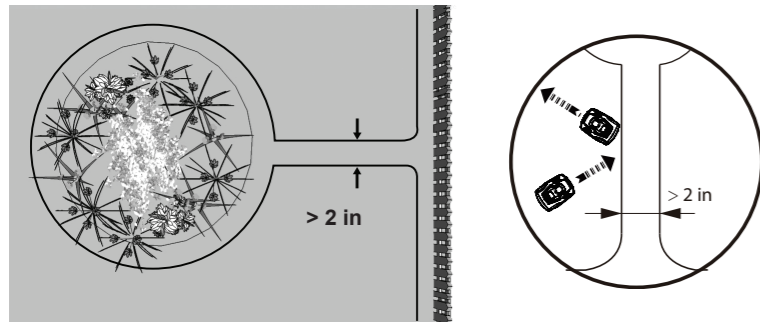

2) Alternatively, keep the distance between the two parallel wires below 2 in. Do not cross the wires - **see below**. This way, the Robotic Mower will not recognise the wires and travel across them unhindered. This option requires placing an obstacle on the boundary wire around the flowerbed. Place the obstacle, e. g. a large rock or pole, near **position A** indicated on the below illustration. The obstacle must be surrounded by a flat area of about 3.3 ft x 3.3 ft, without any slopes. This obstacle will allow the machine to exit the circle.

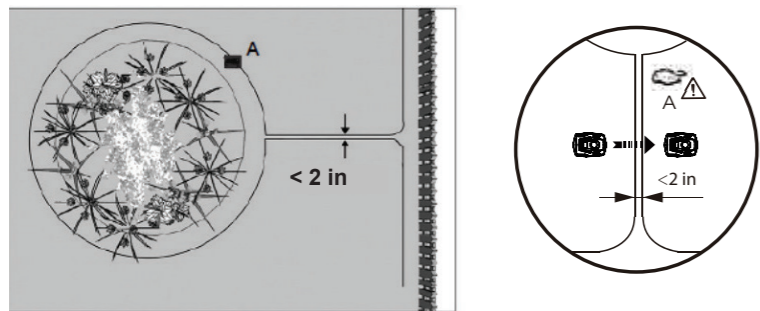

Ponds and Pools

While the Robotic Mower is protected against rain and spray water, being submerged is likely to cause severe damage to the electronic parts.

Therefore, it is imperative to exclude any pools from the cutting area. For added safety, we recommend placing a fence around the pool.

ASSEMBLY

Inventory and garage

If you have created a boundary corridor inside your working area, the corridor should be at least 6.5 ft wide and a max length of 26 ft.

If a corridor is too narrow or too long, the Robotic Mower might not be able to navigate it from one end to the other.

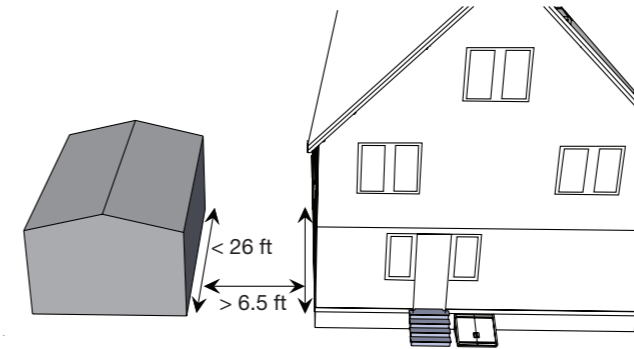

Connect the docking station to the boundary wire

Run the boundary wire underneath the front of the docking station and connect the end of the wire to the left (black) connector marked 'F' (front). After you have placed the wire around the garden then place the other end into right (red) connector marked "B" (back).

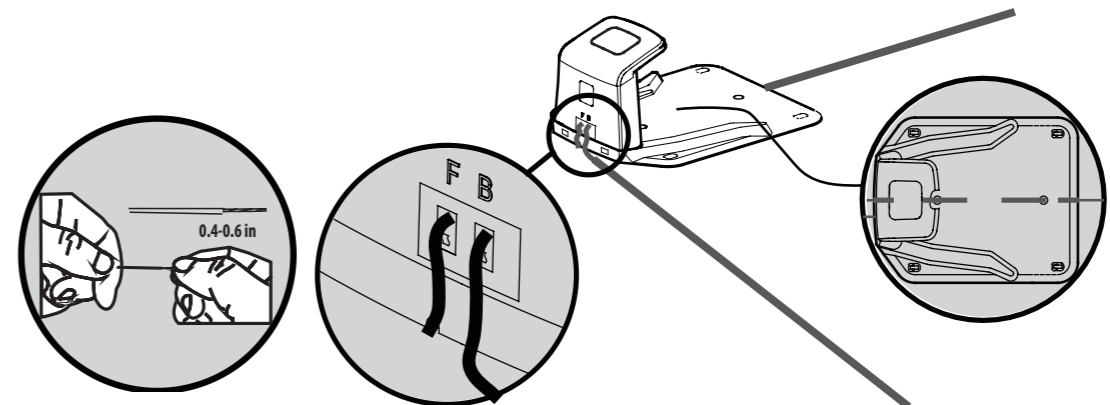

Insert the mains plug into a properly installed socket. Once the blue LED confirms all is OK, test the Robotic Mower's function. Check the LED regularly to ensure fixing the boundary wire has not affected the connection and signal shows S1 on the charging saturation. Then place the Robotic Mower in the working area, a few metres beside the docking station. Set the main power switch to "ON". and then check the S1 signal on the panel is light on, press  4 times to unlock the panel.

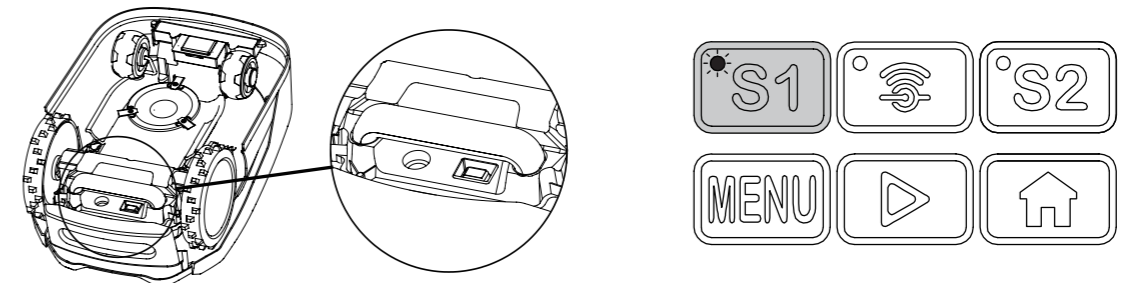

ASSEMBLY

Press the buttons  and then close the lid, a few seconds later, the Robotic Mower should automatically return to the docking station by locating and following the boundary wire in anti-clockwise direction. If Robotic Mower fails to dock correctly, move the docking station to a more suitable position.

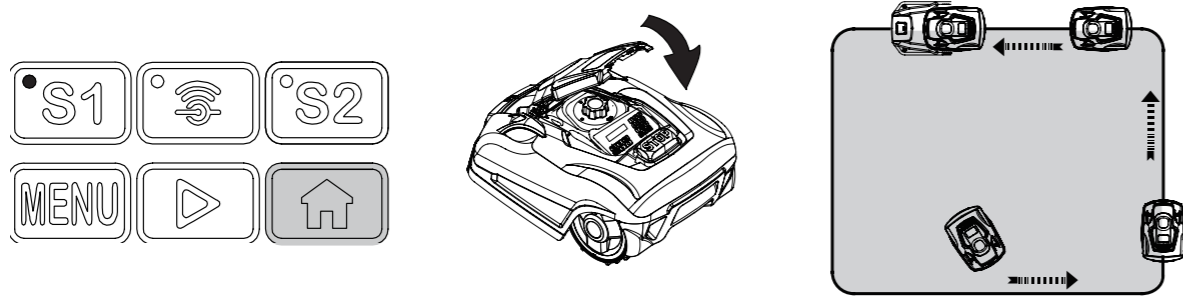

Once the device has docked, "Charging" will show on the display, and the S1&S2 indicators on the docking station will flash alternately. This indicates that the battery is charging correctly.

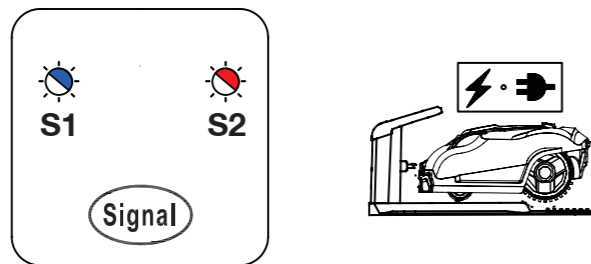

After initial installation, the Robotic Mower will remain in the docking station until the battery is fully charged.

Successful docking and charging indicates that you have found a suitable position for the docking station. You should now drive fixing pegs into ground fully.

Take care not to damage or kink the surplus wire stored under the docking station.

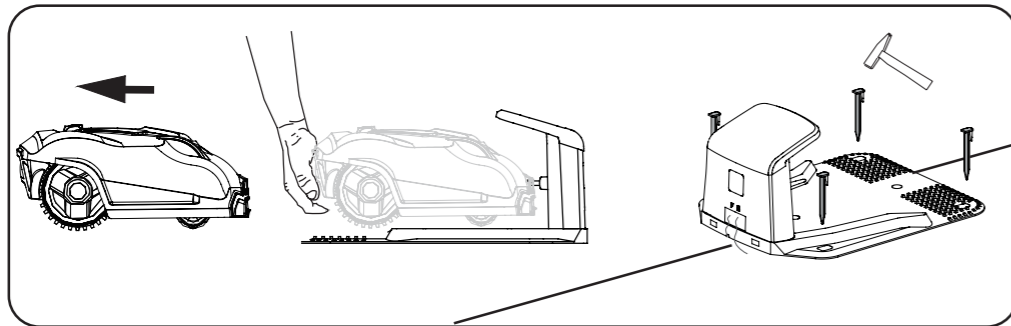

Signal selection

Note: the default signal is S1, no need to change the signal when there isn't a influence signal form the neighbors.

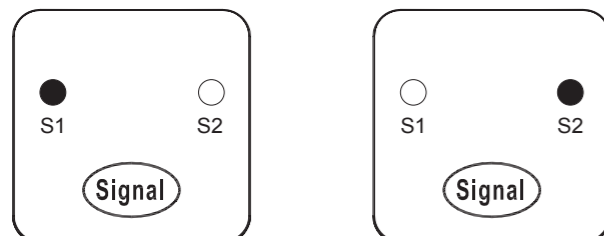

ASSEMBLY

If your neighbour is using the same mower, you will need to keep a distance of 20 in between you and your neighbour's boundary wires to prevent the two devices interfering with each other. Ensure to position your docking station at least 33 ft away from your neighbour's boundary wires and that both products are using different signals. Please refer to section "Signal setting" in order to select signal S1 or S2 for your installation.

1. Press the "signal" button on the charging station, the indicator will be switched to S2.
2. Press the "S2" button on the control panel. the indicator will be switched to S2

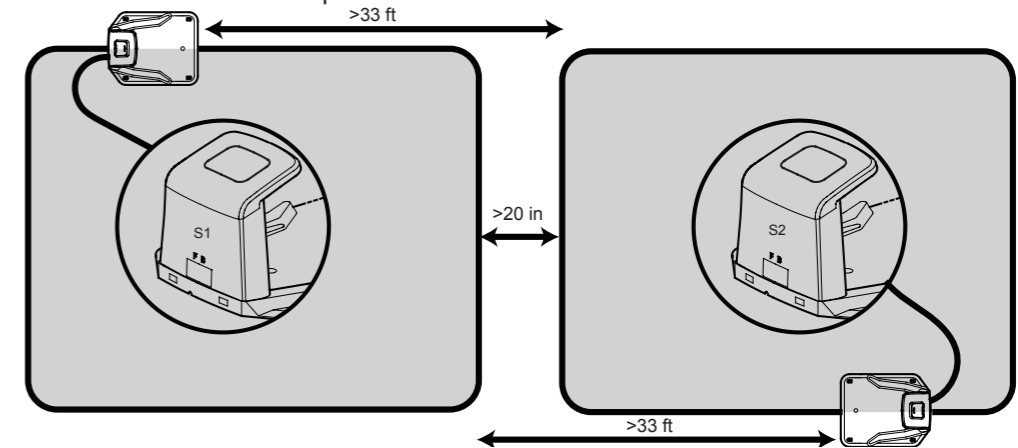

OPERATION

Control panel

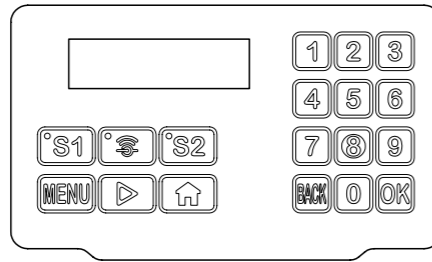

Initial interface

when power on your robotic mower, after entering the default PIN 0000, you will see the initial interface on the display.

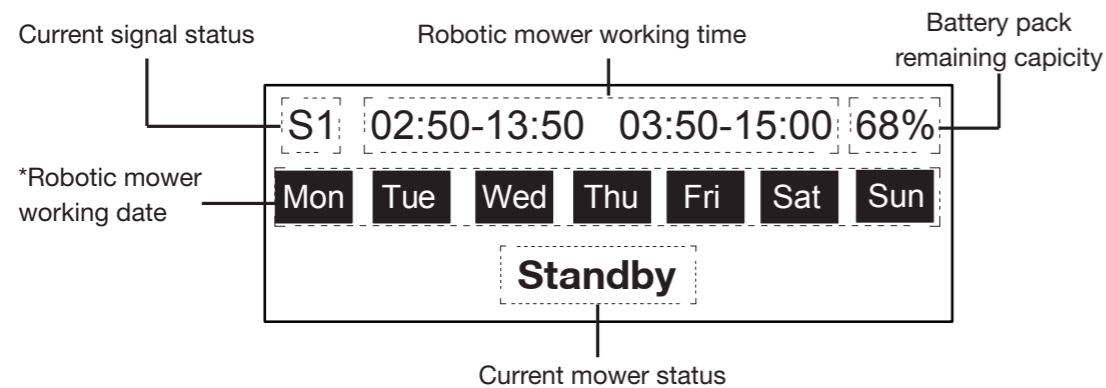
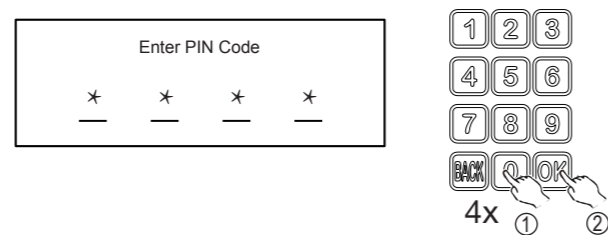

*NOTE: Inverted color means date was selected.



OPERATION

Before starting your robotic mower

Please follow below steps to adjust the time setting before starting your robotic mower.

1. Press the **MENU** button to enter the menu setting.

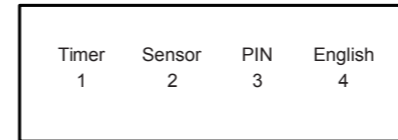

2. Press the **1** button to enter time setting.

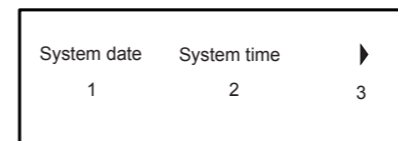

3. Press the **1** button to set the system date

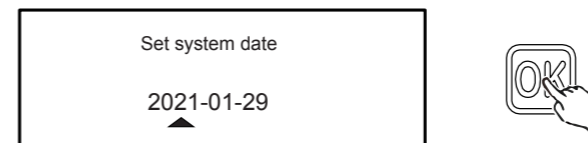

4. Press the **2** button to set the system time

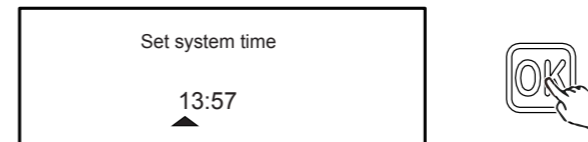

5. Press the **3** button to enter next page

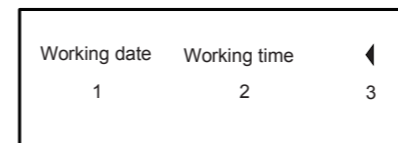

6. Press the **1** button to set the working date

- Press the relative numbers to select the working date your required.

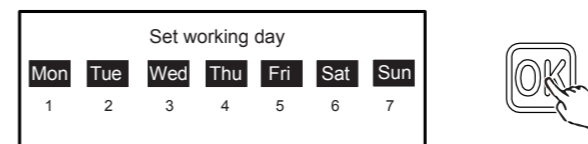

7. Press the **2** button to set the working time

- Press the relative numbers to select the working time your required.

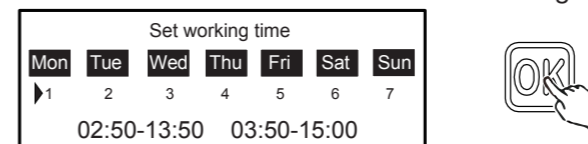

NOTE: If the working day is activated, then the blinking cursor will move to specified time setting.

OPERATION

Sensor setting

1. Press the **MENU** button to enter the menu setting.

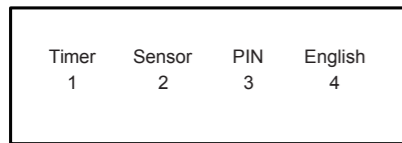

2. Press the **2** button to enter the sensor setting.

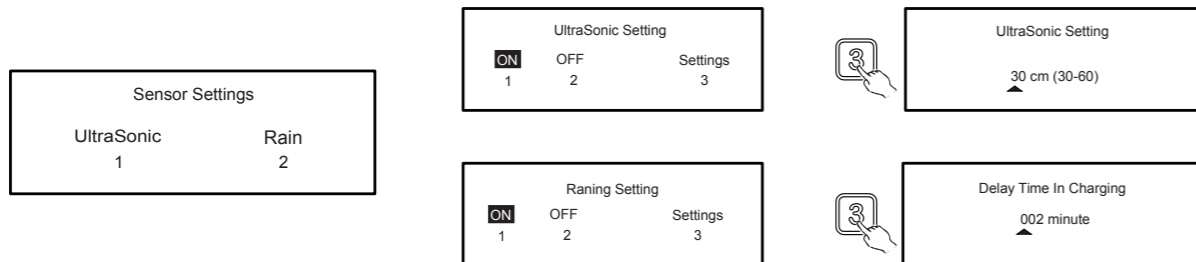

- UltraSonic sensor

This machine equipped 2 ultrasonic sensors which may detect the obstacle on the lawn. When the sensor is activated, the robot will stop and then turn around when detect an obstacle.

Press **2** to switch off the sensor.

Press **3** to elect the detect distance you require.

- Rain sensor

NOTE: Mowing in the rain is not recommended.

This machine has a rain sensor which may stop the robot from mowing in the rain. When the rain sensor is triggered, the robot will go back to the charging station first, where it will be fully charged. Once charged the mower will remain in the charging station until the rain has stopped before starting to mow again.

Note: Be careful not to short circuit the sensors on the machine with any metal objects. This will cause the mower to work abnormally.

Press **2** to switch off the sensor.

Press **3** to set the extra time.

PIN code

1. Press the **MENU** button to enter the menu setting.

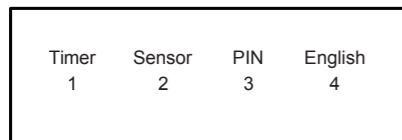

2. Press the **3** button to enter the PIN setting.

- This option sets the passcode of the mower to prevent theft or unauthorised change of the menu settings. The existing (old) passcode is required to change to a new passcode. If you have forgotten the passcode, contact your local dealer or after sales service.

The default passcode of the mower is "0000".

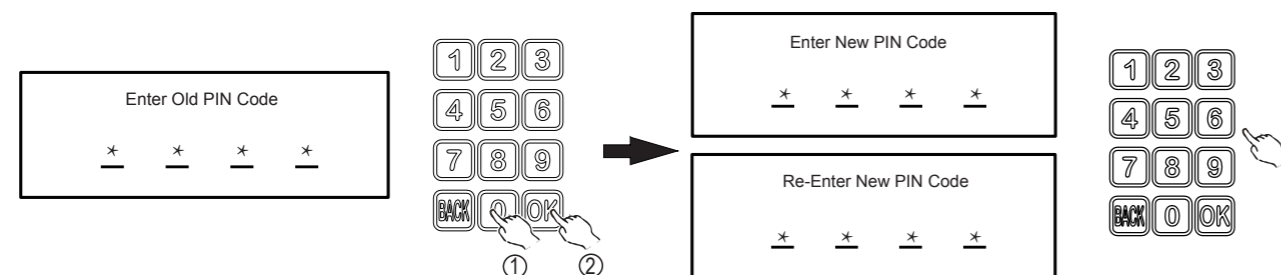

OPERATION

- After re- enter the new PIN, press **OK** button complete this setting.

Language

1. Press the **MENU** button to enter the menu setting.

2. Select related number to set the language you require.



WiFi settings

Press the **MENU** button to enter the menu setting.

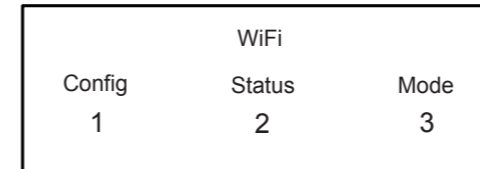

There are 3 further options in "WiFi".

Config

Select this option when you need to connect you mower to APP, see **APP manual**

Status

Show currently WiFi status

Mode

Client Mode-Default mode

Direct Mode-select this mode when you choose direct mode connection you **on your phone**.

Signal setting

- Set you require signal by pressing S1 or S2 button.

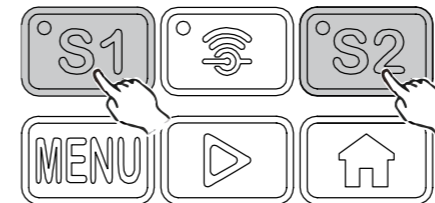

OPERATION

Cutting height adjustment

The cutting height can be adjusted by rotating the height adjustment dial located on the top of the machine. Cutting height range from 1-1/3"-3".

NOTE!

We recommend using an ordinary lawn mower or trimmer to cut the lawn below 2.5 in before using the Robotic Mower. This will ensure you get the optimum performance.

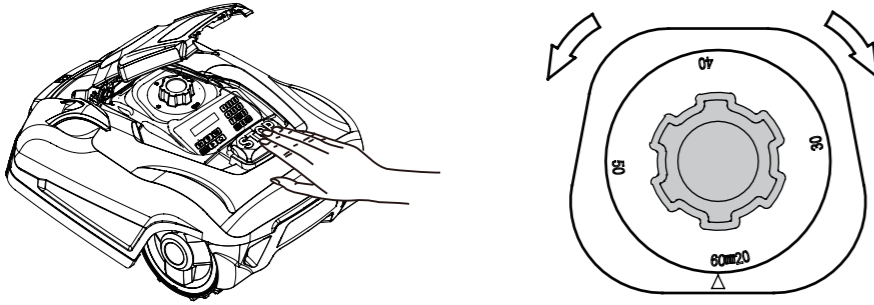

Start mowing

After finishing the time settings, now you can start your Robotic Mower

1. Press the button for 4 times to unlock the panel.
2. Press the button and then close the lid, the Robotic Mower will start to work.

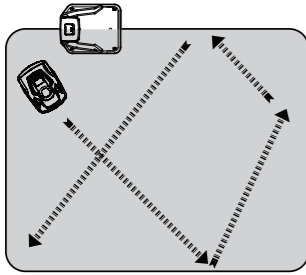

Return to the docking station

1. Press the button for 4 times to unlock the panel.
2. Press the button and then close the lid, the Robotic Mower will back to the docking station.

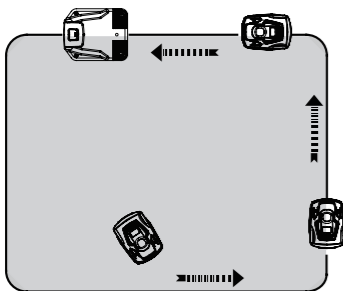

Emergency Stop

Press STOP button to halt the mower at any time.

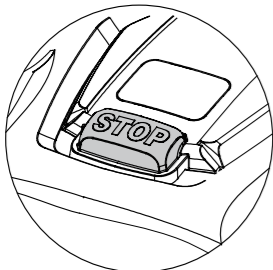

MAINTENANCE AND STORAGE

Maintenance work that has not been described in these instructions must be carried out by a servicing agency authorised by the manufacturer. Only use original parts.

Maintenance

Check and clean your Robotic Mower regularly and replace worn parts if necessary. Preferably use a dry brush, a damp cloth or a sharpened wooden piece.

Never use flushing water.

Following these maintenance instructions can extend your Robotic Mower's service life.

Battery Life

The Robotic Mower has a maintenance free Li-ion battery, with an estimated life of more than 2 years (depending on treatment and usage).

Winter Storage

During winter, keep your mower, docking station and power supply in a dry place.

We recommend a shed, garage or preferably store it indoors.

Prepare your device for winter storage as follows:

1. Fully recharge the battery.
2. Set the mains power switch to "OFF".
3. Thoroughly clean your Robotic Mower.
4. Unplug the power supply from the mains outlet.
5. Disconnect the power supply from the docking station.
6. Disconnect the boundary wire from the docking station. Lift up the docking station and clean. The boundary wire can remain outside. However, it is imperative to protect the wire against corrosion. We recommend a water-free grease or suitable sealing tape.

If available, repack the product in the original packaging.

Alternatively, our service centre offers a winter service for your device. This will include a check-up of all parts and - if available - a software upgrade.

Preparing for spring

After winter storage, please clean the charging contacts on both the Robotic Mower and the docking station.

Use a fine abrasion paper or a brass brush; this will help to achieve the best charging efficiency and avoid any charging interference.

Cleaning the mower body

As your Robotic Mower is battery powered you need take care when cleaning. Remove rough dirt with a soft brush. Use a manual water spray with mild household detergent for intensive cleaning. Wipe off any residue after cleaning with a moist rag.

Disposal

To help the environment, please dispose of the product properly when it has reached the end of its useful life and not in the household waste. Information on collection points and their opening hours can be obtained from your local authority.

Li-Ion environmental damage through incorrect disposal of the batteries / rechargeable batteries.

Remove the battery pack from the product before disposal. Batteries /rechargeable batteries may not be disposed of with the usual domestic waste. They may contain toxic heavy metals and are subject to hazardous waste treatment rules and regulations. Please dispose of batteries according to the relevant local requirements.

Replacing the battery

While the actual battery life will depend on usage and environmental factors, the typical service life is several years. Spare batteries are available from customer support. To replace the battery, please follow the instructions below.

MAINTENANCE AND STORAGE

1. Ensure the main power switch is turned OFF. Clean the underside as instructed.
2. Set the Autonomous Mower to the lowest cutting height.
3. Turn the mower upside-down. Remove the 5 screws fixing the battery compartment's lid. Note one screw is partially covered by the blade protector and is only accessible through a service hole.
4. Pull out the battery and disconnect it from the Autonomous Mower.
5. Carefully clean the lid and the edge of the battery compartment. Debris may allow excessive water to enter the battery compartment, causing major damage to the appliance.
6. Connect and insert the replacement battery, close the compartment and fix the lid with 5 screws. Do not turn on the Autonomous Mower before placing it back on its wheels. Beware of sharp blades!

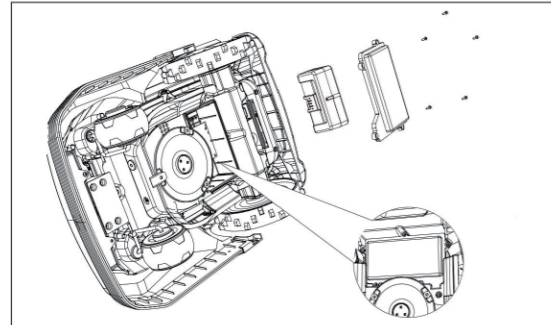

Cleaning the underside

Ensure the main power switch is in OFF position. Wearing protective gloves, turn the Robotic Mower onto its side to expose its underside. Clean the blade disc and frame using a soft brush or damp cloth. Rotate the blade disc to make sure that it can move freely, check that the blades can turn on their pivots and that there is no grass is obstructing them.

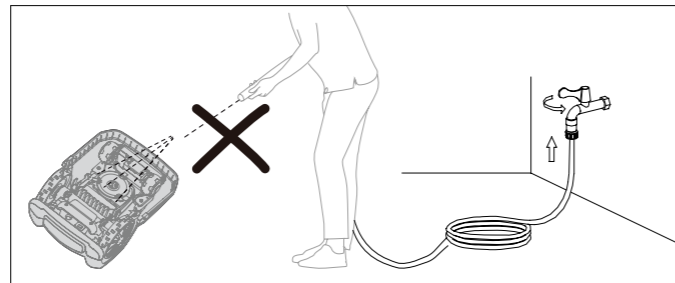
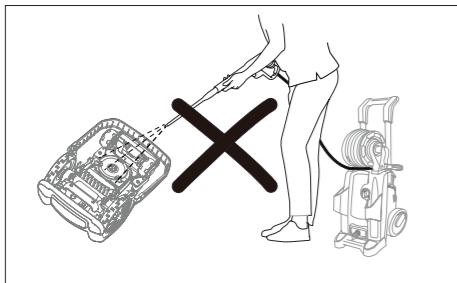

Clean the contact pins and the charging strips

Using wire wool, metal cleaner or very fine grade emery paper, clean the contact pins and the charging strips on your mower and docking station. Remove any debris, leaves, or grass clippings around the contact pins and charging strips to ensure efficient charging.

Reversing or replacing the blades

⚠ WARNING !

Ensure the Robotic Mower is completely shut off before cleaning, adjusting or replacing the blades. Always wear protective gloves.

⚠ WARNING !

To ensure maximum cutting efficiency and safety, always use recommended replacement blades and blade mounting parts when replacing.

MAINTENANCE AND STORAGE

Your Robotic Mower has three blades, fixed to the blades disk. Unless damaged by hard obstacles, these blades can last for up to five months of everyday use. Weekly inspection of the blades and the fixing screws is advised. Note that the blades are double-edged. When the first side becomes blunt, loosen the fixing screw and the blade upside down and re-fix. Check that the blade can move freely.

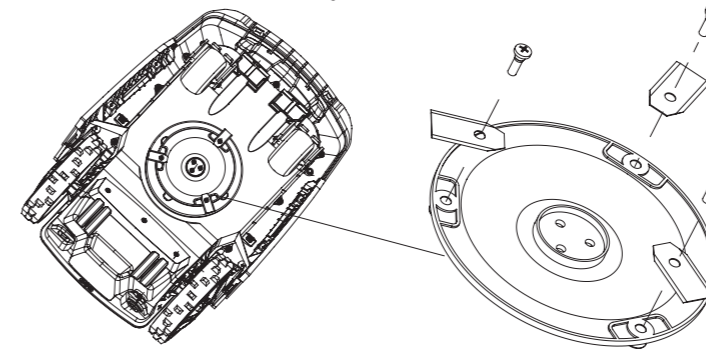

A set of spare blades is included with the Robotic Mower. More blades can be purchased via customer support.

To ensure you get the best performance from your machine, always replace all three blades at the same time. Only use spare parts recommended by manufacturer.

NOTE: if blades have been removed/ changed, please ensure that the screw is firmly secured in place and that the blade is free to move.

Spare parts list

In case you need spare parts or any support with your device, please call our after sales centre.

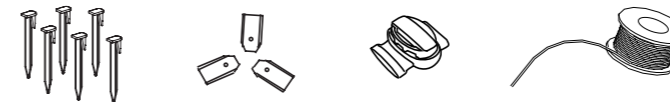

TROUBLE SHOOTING

Robotic Mower cannot dock with docking station

- Check that the boundary wire in front and underneath the charger is in a straight line.
- Check that the docking station's position is suitable as explained in this manual.

Robotic Mower runs in circles while mowing or while following boundary wire back to docking station

- Verify that no power cable runs parallel and in close proximity the boundary wire. If necessary, reposition the boundary wire.
- Check if a front wheel is stuck.
- If a neighbor has a similar Robotic Mower, the signals may interfere. Try setting your docking station and Robotic Mower are set to the alternative boundary signal S1 to S2.
- Driving motor may be damaged, please contact customer support.

The Robotic Mower is noisy

- Inspect the blade fixing screws; tighten if necessary.
- Inspect the blades for damage; replace if necessary.
- Grass may be too high. Try increasing the cutting height, or mow the lawn with an ordinary lawnmower first.
- Cutting motor failure, please call after sales service.

Mower remains at or returns to docking station when pressing START button

- Check if the mower has already completed the programmed working time for that day.
- Battery is low, the Robotic Mower needs to be charged.

LED signal indicator on docking station

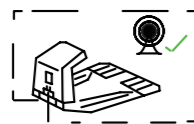
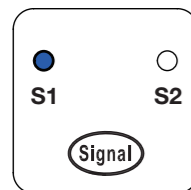

S1/S2 indicator lights on.
Boundary wire signal in good condition.

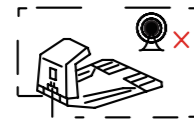
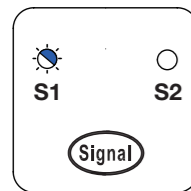

S1/S2 indicator flashes.
Boundary wire broken, no signal.

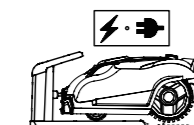
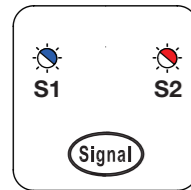

S1/S2 indicator flashing alternately.
Mower is charging in the docking station.

TROUBLE SHOOTING

Charging trouble shooting

Problem	Possible cause	Corrective action
No light on charge base	Incorrect wire connection	Check wire connections "F and B"
	AC Power has not been switched ON	Switch on AC power
S1 or S2 indicator flashes separately	Boundary wire broken, no signal	Repair broken cable with provided connectors
Robot not charging	Machine not correctly docked in charge base	Check machine is fully docked in charge base
	Charger pins corroded	Check charge base is on flat surface Clean the charger pins

Mowing trouble shooting

Problem	Possible cause	Corrective action
No Power to machine	ON/OFF key has not been activated	Switch ON the machine and try again
	Robotic Mower has low charge	Place machine in the docking station
Machine fails to START	Time setting not activated	Select time schedule and then try again
	Grass build up under deck	Clean under deck with brush
	Battery power low	Place machine in docking station
	Grass too long	Mow the lawn to 2.5 in
	Cutting height is too low	Mow the lawn to 2.5 in and raise cutting height
	Battery temperature too cold /hot	Working condition is between 40°F and 113°F
Boundary wire broken	Repair broken boundary wire	
Mower outside the boundary wire	Boundary wire is on a slope	Modify boundary wire and leave bigger distance on slope
Parts of the lawn are uncut	Mower needs more cutting time	Increase scheduled cutting time
	Grass too long	Mow the lawn to 2.5 in
Mower gets stuck in Lawn area	Obstacles on lawn	Remove obstacles from the lawn
	Boundary wire not correct laid	Modify boundary wire to zone out obstacles
	Wire in front of docking station incorrect installed	5 ft of straight cable to front of docking station needed
Excessive vibration/noisy	Blade loose	Tighten screw bolt
	Blades damaged jammed	Replace damaged blades
	Grass maybe to high	Increase cutting height, reduce later step by step or mow the lawn with ordinary lawnmower first
Mower runs in circles	Cutting motor failure	Please call the after sales service
	Power cable runs parallel/close to wire	Reposition of boundary wire
	Front wheel is stuck	Clean front wheel area
	Signal interfere with robot in neighborhood	Change to alternative boundary signal (S1/S2)
	Driving motor failure	Please call after sales service
Connection issue or broken/cut boundary wire	Repair/check connections on charge base and boundary wire being broken/cut	

WARRANTY

YARD FORCE TWO YEAR LIMITED WARRANTY

Product Warranty

Please keep your original purchase receipt in a safe place as proof of purchase. Warranty coverage for this product must be verified by the original purchase receipt. The warranty period begins on the day that the product was purchased from an authorized retailer of Yard Force products. Warranty coverage only applies to the original purchaser and is not transferable. Warranty coverage is only provided on products purchased and used in the USA and Puerto Rico from authorized Yard Force retailers. Products purchased or used outside of the USA and Puerto Rico are not covered by this warranty.

(2) Two-Year Warranty

NX100i has a Two- Year Limited Warranty from the date of purchase against manufacturer defects for residential use only. Commercial use voids the warranty. This warranty does not cover accidental damage, unreasonable use, normal wear and tear, neglect or non-compliance with the Operating, Safety and Maintenance Instructions. All service, outside of normal maintenance as described in this manual, must be done by an authorized service technician. Any unauthorized service or changes to the original configuration of this product will void the warranty. All parts and accessories used on and with this product must be manufacturer/or and authorized by Merotec Inc.

(90) Ninety-Day Warranty – Accessories

The accessories included with the Robotic Mower; like the blade, and other similar parts are warranted against manufacturer defects for residential use only for a period of 90 days from date of purchase.

Warranty does not cover loss of use or other consequential damages arising from any of the above, nor does it cover repairs made or attempted by unauthorized persons. This warranty is void if the product is used for commercial, rental or industrial purposes. Certain parts, attachments and accessories are subject to normal wear and tear and are excluded from the warranty.

Service and Warranty Claims Process

Contact the Yard Force Support Center toll-free at **(866) 902-9690 Monday-Friday between 8:30 AM and 5:00 PM** Eastern Time for service and warranty support. Yard Force USA Service Support agents can help you troubleshoot problems over the phone to get you back up and running as quickly as possible. In the situation where service or warranty inspection is needed, please follow these steps:

1. Contact Yard Force USA at **(866) 902-9690 or support@merotecusa.com Monday-Friday between 8:30 AM and 5:00 PM Eastern Time.**
2. Send in proof-of-purchase and serial number (if applicable) to confirm warranty coverage.
3. If service or a warranty evaluation is requested, Yard Force USA will provide an RGA number that should be used in all communications with Yard Force USA and if necessary a list of local authorized service centers to bring your tiller to for evaluation and repair.
4. All shipments to Yard Force USA must have an RGA number. Any shipment received that does not have an RGA number clearly marked on the outside of the box will be refused.
5. All shipments must be sent pre-paid, Yard Force USA does not pay for any shipping costs for service or warranty evaluation. Yard Force USA is not responsible for any packages that are lost by carrier. We recommend that shipments are made by a carrier that provides tracking and delivery information.

For more information or to ask questions, please call toll-free **(866) 902-9690 or support@merotecusa.com Monday-Friday between 8:30 AM and 5:00 PM Eastern Time.**

SAVE THESE INSTRUCTIONS